







Part No.	Part Description	Amount	Unit Price	Total Price	
7222758	100mm Clear PVC Pressure Pipe 500mm long	1			
1161887	100mm Coupling	1			
1164851	100mm BSP PVC socket	1			
22578333	4 inch Plug Polypropylene BSP	1			
1990232	Cannot ship The solvent NO SOLVENT	0			
	Stainless Steel Tube 25.4 x 1.6 x 280mm 316L Unpolished	7			
	Stainless Steel Tube 19.05 x 1.6 x 320mm 316L Unpolished	7			
	PVC End Caps	14			

	4 Terminal Elec. Connector	1			
	Marine Grade Stainless Steel Hose Clamp 70 x 90 mm	1			
	Marine Grade Stainless Steel Hose Clamp 40 x 55 mm	1			
	Rubber O Ring Seals 4mm x 2 mm	8			
	4.5 ml x 100mm Grey PVC disk	1			
	5 mm x 60 mm Stainless Steel 316 Hex Set Screws	8			
	5 mm Nuts Stainless Steel	32			

	5 mm Flat Round Washers Stainless Steel	16			
	Elec. Terminal Connectors Ring Eye	8			
	Miscellaneous. Anode SS Bolt with eyelet and copper wire for cathode connections				

Bottom Plate Template

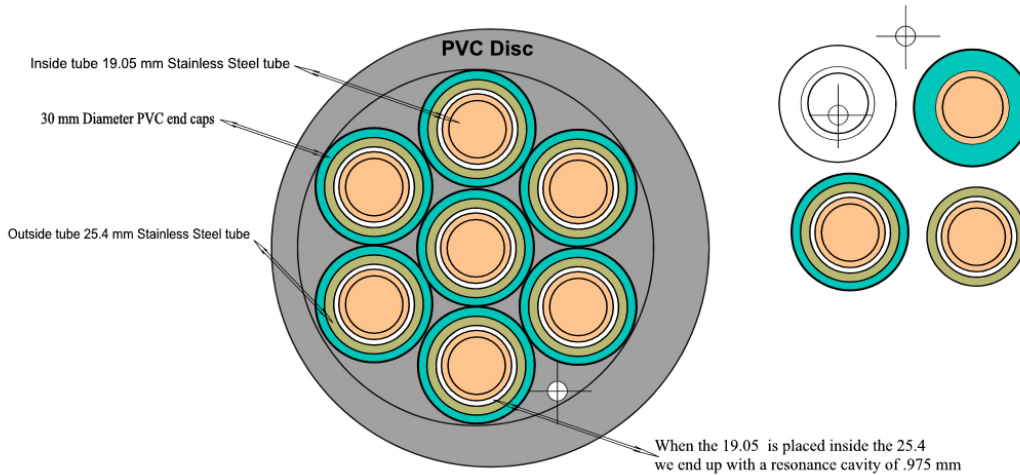

Cell Construction

Hydrogen Water Fuel Cells Stainless Steel 316.



Inside tube 19.05 mm Stainless Steel tube
Outside tube 25.4 mm Stainless Steel tube

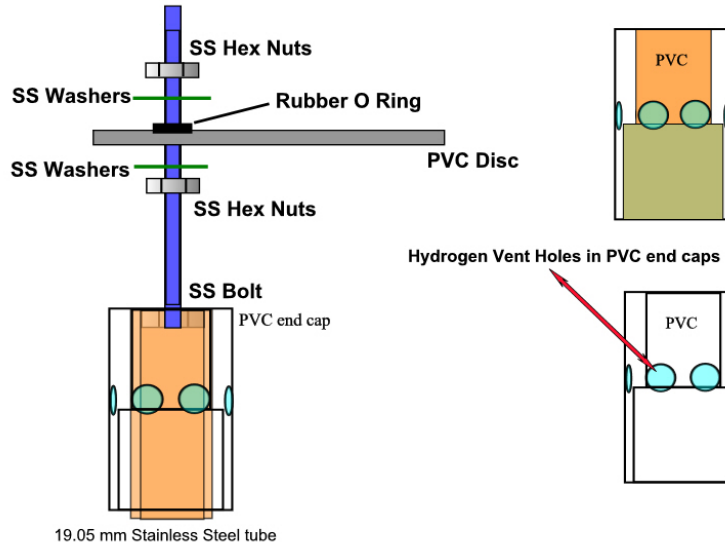

30 mm PVC end caps

Machined from a solid piece of PVC to provide the correct spacing for the two tube when placed on the ends of the SS tubes

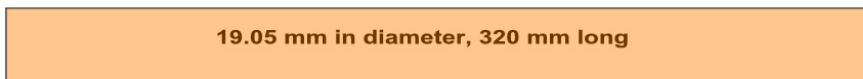
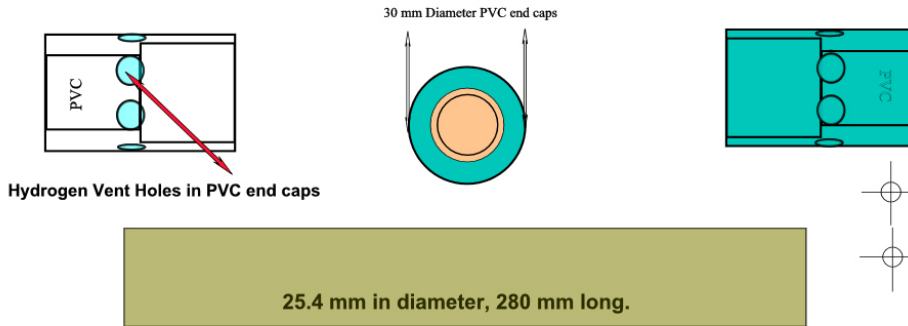
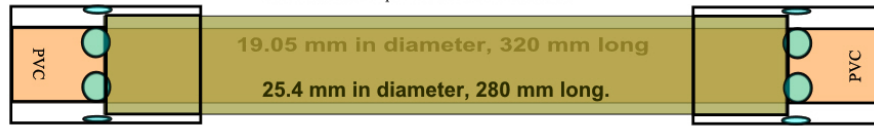

Cell Construction

Outside tube 25.4 mm Stainless Steel tube
25.4 mm in diameter, 280 mm long.

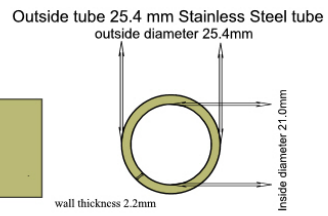

Inside tube 19.05 mm Stainless Steel tube
19.05 mm in diameter, 320 mm long

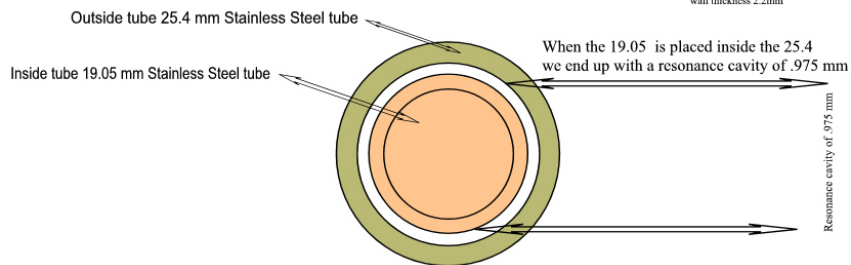
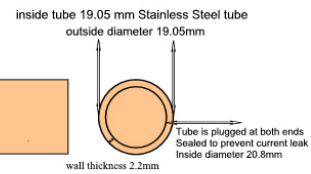

Water Fuel Cell

Outer tube is the anode +

Inner tube is the cathode -

